

F. Wilhelm Bruns

**Hyper Bonds
-Enabling Mixed Reality-**

**artec-paper Nr. 82
März 2001**

ISSN 1613-4907



artec | Forschungszentrum Nachhaltigkeit
Enrique-Schmidt-Str. 7
Postfach 330 440
28334 Bremen

A generalized concept to blend physical systems with their virtual counterparts, being their computer-internal representation or a functional continuation will be introduced. *Hyper-Bonds* combine the unified abstract systems representation of bond graphs with their concrete implementation in a “hyper-connection” between physical phenomena of the computer-external environment and the logical structure of computer-internal representations in a vivid way. The theory is laid down and a first application in a learning environment for electro-pneumatics, allowing a free determination of boundaries, is shown. Further applications and extensions are highlighted.

1. Introduction

Mixed realities are becoming more and more popular. They represent a kind of coupling of real world phenomena to various information, represented within a computer. This might take place in the sense that information is displayed and overlaid to real phenomena (see Augmented Reality research: Weiser 1993, Wellner 1993), in the sense that real phenomena are used as handles to manipulate information (see Graspable User Interface research: Fitzmaurice et al 1995) or in the sense that both worlds are bi-directional tight together (Ishii & Ullmer 1997, Brave et al 1998). The focus of this paper is the later approach.

In some previous work, we introduced the concept of complex objects (Bruns 2000) being objects with a real concrete part coupled to various virtual representations by means of grasp- or image-recognition, Fig. 1. The fruitful application of this concept in several environments for learning and systems design has been demonstrated in some school applications (Grund & Grote 2000). There is also strong evidence from other authors, that constructivist learning based on concrete objects has many advantages (Brereton & McGarry 2000). At least this can be observed for certain learning styles.

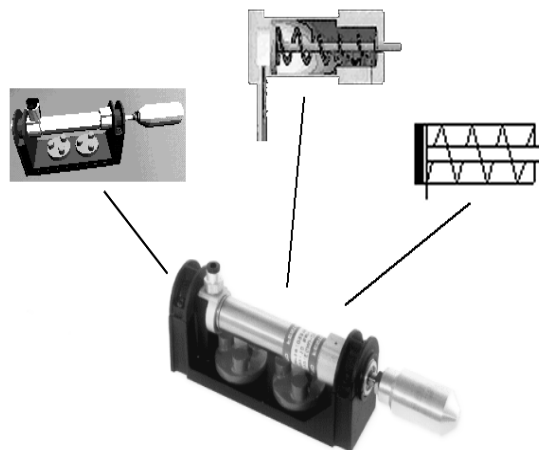

Fig. 1: Complex Object

This coupling so far has been only unidirectional, giving the possibility to build and change real systems and synchronously generate their functional representatives. Simulation could then be carried out with the virtual model and compared with the behavior of the real system, but no interactive bi-directional connection was realized. However it was possible, to download the controlling algorithm, driving the virtual model, as a whole to a Programmable Logic Controller (PLC) and drive the physical system by means of sensors and actors, Fig. 2. Our first extension of this concept was a bi-directional pneumatic link between the virtual and the

real model, being able to sense and generate all relevant air pressure and flow phenomena via one connection (Bruns&Gathmann 1999), Fig. 3.

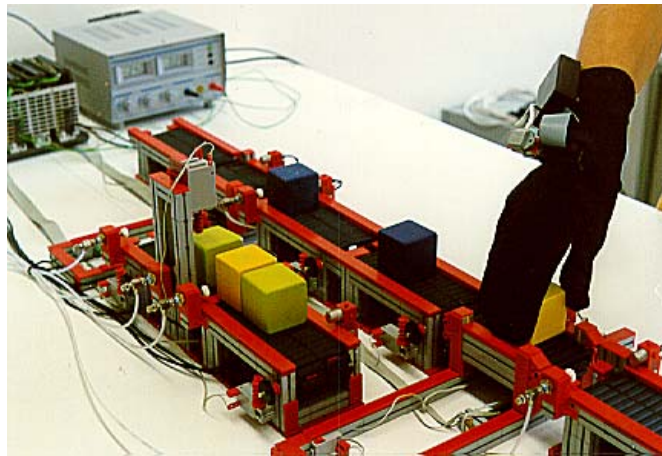

Fig. 2: Driving a real Model with a PLC

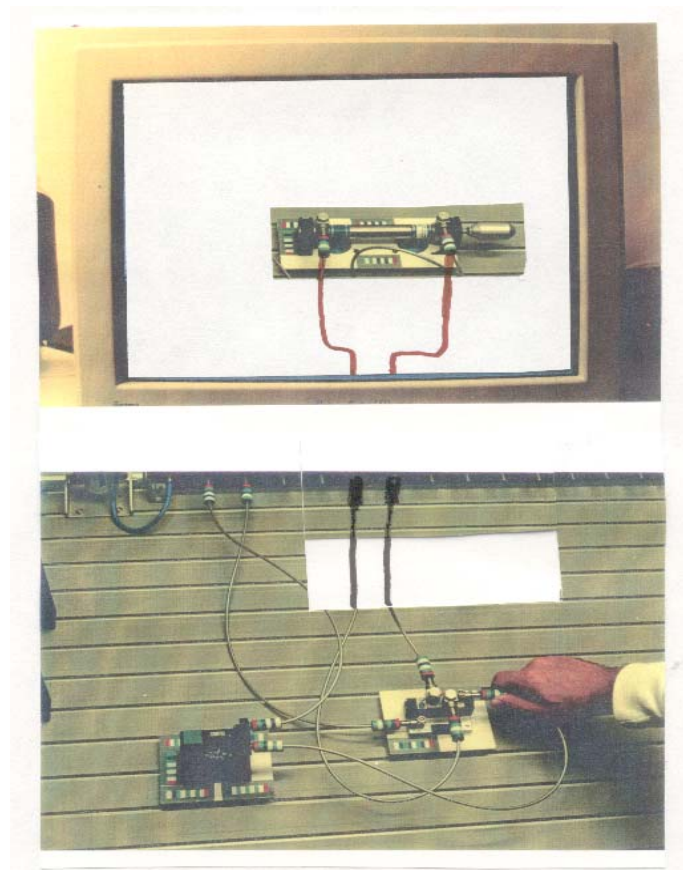

Fig. 3: Reality with a hole

The concept is now generalized towards further physical phenomena, from pneumatics, hydraulics, electrics, mechanics, thermodynamics. The unifying concept allowing this approach is the Theory of bond graphs (Paynter 1961, Karnopp 1995). Its implementation is done by PLC-technology.

At first, a short recall of bond graphs is given and their usefulness for this approach shown. A short motivation for Hyper-Bonds from a system dynamics point of view follows. In section 3

the detailed concept of *Hyper-Bonds* is introduced. Some applications and perspectives finish this contribution.

2. Usefulness of Bond Graphs

Paynter introduced the theory of bond graphs as a unifying view on physical phenomena from a continuity of power-flow perspective. Power flows through system components and connections by way that the product of effort and flow is continuous, following typical laws of energy conservation and power-flow continuity. Effort (e) is the driving force for flow and can be a pressure difference, force and torque, electrical potential difference, temperature difference etc. Flow (f) can be a flow of material, momentum, electric current, entropy. Bond graphs are networks with edges of (e,f)-connection and nodes with constant e (0-node) or f (1-node). Bond graphs can be used to describe dynamic behaviors of different physical domains with one formalism (Fig. 4-5), similar the way we use differential equations for all kinds of physical phenomena. In fact, for calculation means, bond graphs are transferred to systems of differential equations and then integrated (symbolic or numerical). For engineering purposes bond graphs have several advantages as they are vivid and preserve important constraints (Cellier et al 1995). One important feature of bond graphs is the input-output relation of effort and flow, seen from a physical component perspective. Components are always connected by bonds having the value pair e and f where one of them can be seen as input the other as output from a cause-reaction point of view. However, which one is input and which one output can only be determined from an overall systems view by causal reasoning. Knowing e and f at one connection, resulting from calculation or measurement, allows a cutting of the system in two parts and a separate investigation.

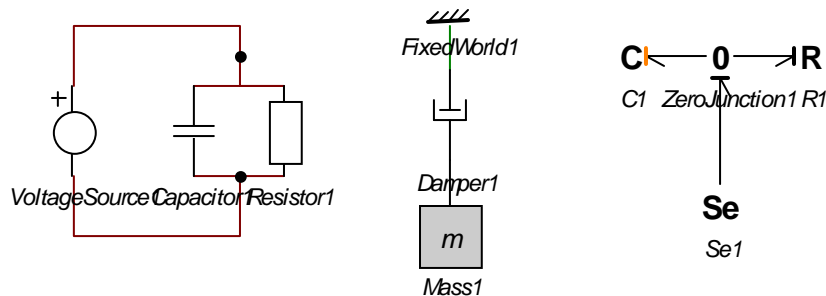

20-sim3.1 demo (c) CLP2000

Fig. 4: Bond graph for equivalent mechanical and electrical systems

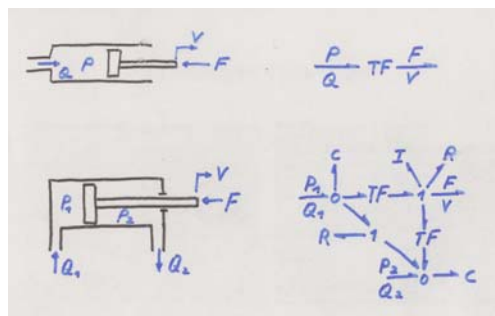

Fig. 5: Bond graph for a pneumatic cylinder with different levels of abstraction

Bond graphs are especially useful for the description of mechatronic systems, where power-flow is transformed and exchanged between different forms of energy, Fig. 6. Several simulators now support the notation of bond graphs.

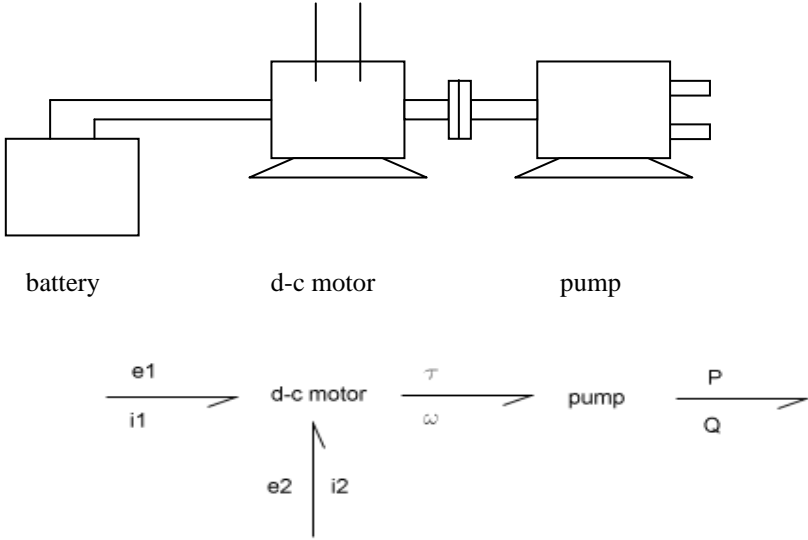
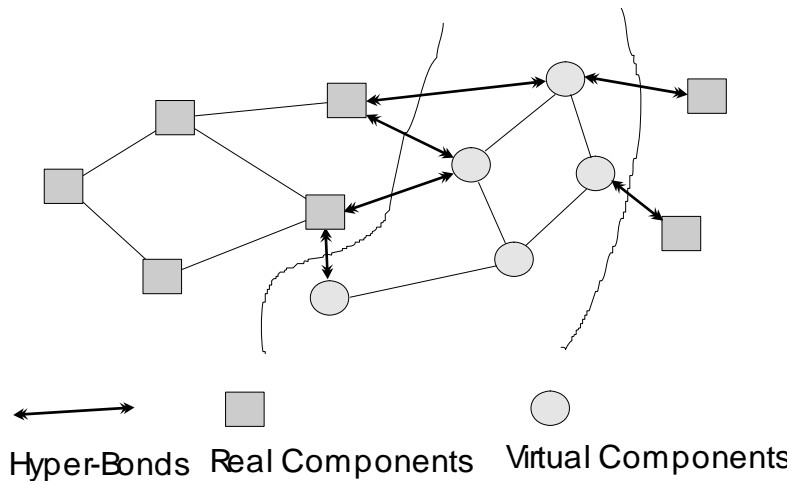

Fig. 6: Mechatronic System described by bond graph

The feature of effort and flow, determining a systems behavior can be used fruitfully, to implement arbitrary cuts in an overall system, realizing one part in reality, the other one in virtuality and provide a mechanism to sense and generate arbitrary efforts and flows. This will be demonstrated.

3. Systems and Boundaries

In physical science, and not only there, we learn the principle of cutting a system at well defined boundaries and replacing the external influences by some observable and measurable relevant variables, reducing the investigation to the internal dynamics of the rest. In laboratory work we use this principle to construct reproducible experiments, but also mentally we use it to think about systems in hypothesis and mental experiments (consider the principle of virtual work applied by d'Alembert). For future laboratories, being more and more penetrated by computers, a free and easy distribution of a system between reality and virtuality seems to have some advantages (Fig. 7). Certain well known aspects of a system can be represented in a formal way by algorithms in the computer, others to be investigated in more detail and uncertainty are represented in reality, but coupled to a dynamic surrounding. This would allow completely new forms of easy experimental work and learning.



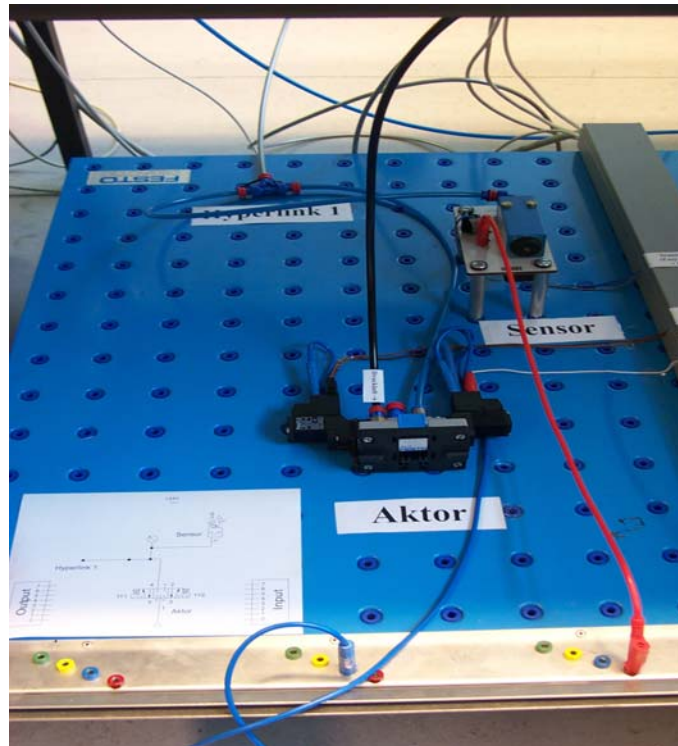
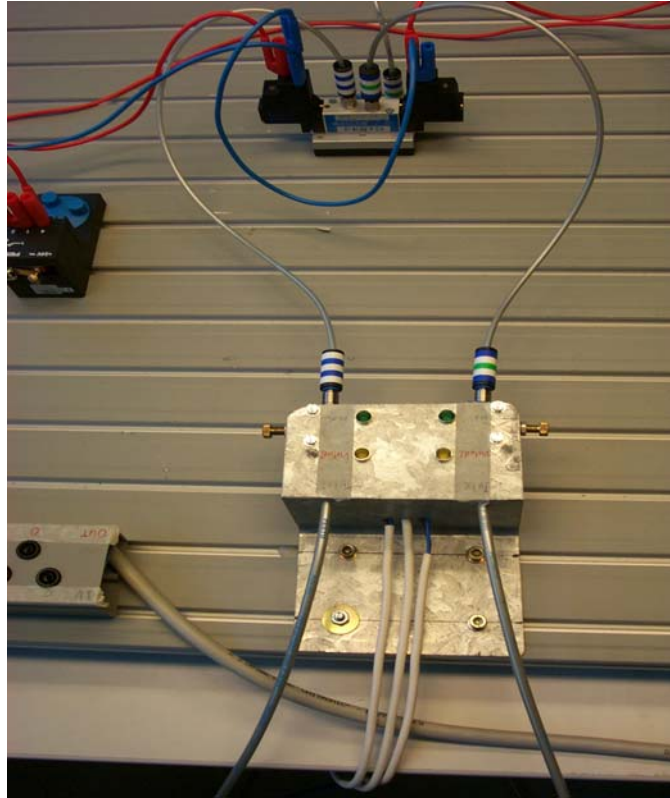

Fig. 9: Implementation of a Pneumatics Hyper-Bond
 (lower picture shows implementation, upper picture application side)

The integration into a virtual construction and simulation environment has been done by some parallel digital and analog I/O ports, Fig. 10. To be more flexible, the I/O can be handled by a separate box or PLC, connected to the PC via bus or serial interface.

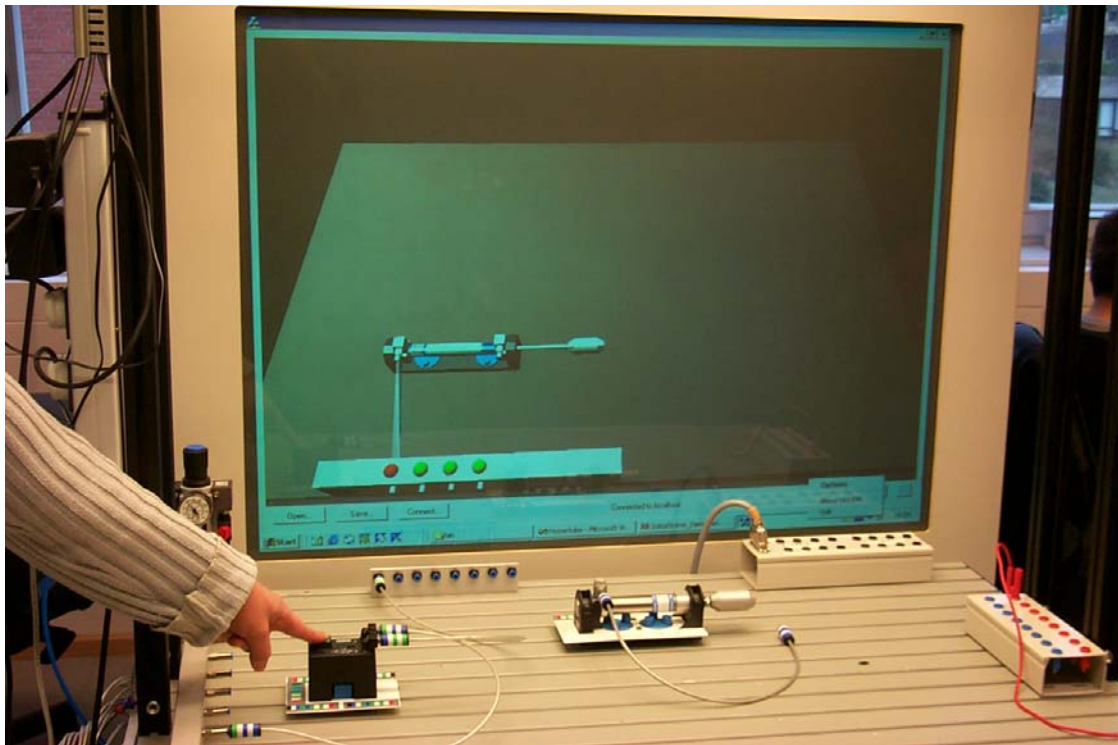

Fig. 10: Integration of Hyper-Bonds in some application

5. Applications and further Perspectives

The new concept of Hyper-Bonds is being applied in a learning environment for electro-pneumatics (Fig. 11), where students can work on complex systems, freely switching between virtuality and reality¹. Especially if one is interested in a work-process-oriented learning, using authentic situations and always wants to see the complex context, it is of high value, to be able to select certain interesting aspects of a system, put them as real components on ones desk, but still have them connected to and integrated in the overall system. As the virtual model can easily be distributed over different locations (only with some restrictions in time behavior), one has the possibility to have one complex virtual system materialized in parts at one location and in parts at other locations. This opens completely new perspectives for distributed task oriented learning in a co-operating group. For systems development our concept would support an incremental implementation and testing of complex devices. For service and maintenance it would support the stepwise investigation and repair of dis-integrated parts.

We have shown so far how to implement *Hyper-Bonds* in the domains of electrics and pneumatics, the implementation for hydraulics, thermodynamics and mechanics should follow.

¹ EU-IST Project DERIVE (Distributed Real and Virtual Learning Environment for Mechatronics and Tele-Service

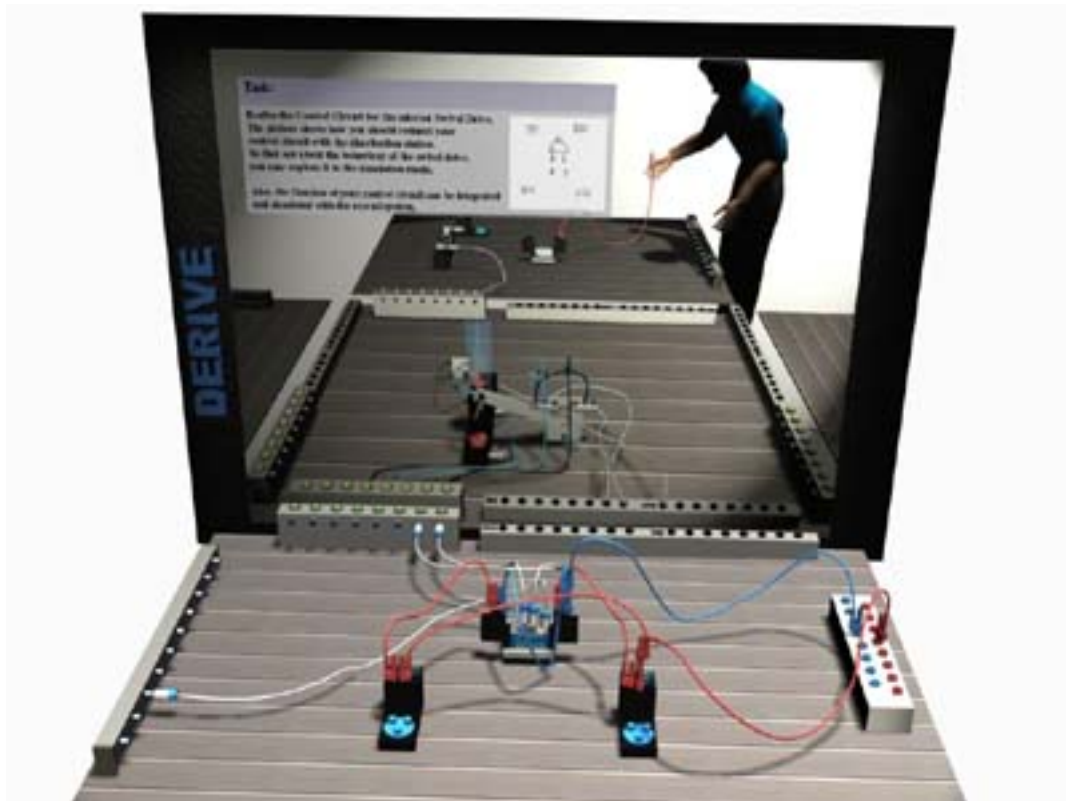

Fig 11: DERIVE Learning Environment

References

- Brauer, Volker. Simulation Model Design in Physical Environments. Computer Graphics ACM Siggraph vol 30, no. 4, pp. 55-56, 1996
- Brave, S., Ishii, H., Dahley, A.: Tangible Interfaces for remote Collaboration and Communication. Proc. Of CSCW '98, Nov. 14-18, 1998
- Brereton, M., McGarry, B.: An Observational Study of How Objects Support Engineering Design Thinking and Communication: Implications for the design of tangible media. CHI 2000 Conf. Proceedings, acm press, pp. 217-224, 2000
- Bruns, F. W.: Zur Rückgewinnung von Sinnlichkeit - Eine neue Form des Umgangs mit Rechnern, Technische Rundschau, 29/30, 1993, pp. 14-18
- Bruns, F. W.: Complex Construction Kits for Coupled Real and Virtual Engineering Workspaces. CoBuild '99
- Bruns, F. W., Gathmann, H.: Auto-erecting Agents for a collaborative Learning Environment. Proc. of 8th IEEE Int. Workshops on Enabling Technologies: Infrastructures for Collaborative Enterprises, June 16-18, Stanford, 1999, 287-288
- Cellier, E. F., Elmqvist, H., Otter, M.: Modeling from Physical Principle. In W. S. Levine (Ed): The Control Handbook, CRC Press, Boca Raton, 1995, pp 99-108
- Fitzmaurice, G. W., H. Ishii, W. Buxton. Bricks: Laying the Foundations for Graspable User Interfaces. CHI'95 Mosaic of Creativity, 1995, pp. 442-449

Ishii, H., B. Ullmer, B. Tangible Bits: Toward Seamless Interfaces between People, Bits and Atoms. CHI'97, Atlanta, Georgia, 1997

Karnopp, D. C., Margolis, D. L., Rosenberg, R. C.: System Dynamics – A unified Approach. John Wiley, New York, 1990

Paynter, H. M.: Analysis and Design of Engineering Systems, MIT Press, Cambridge, MA, 1961

Weiser, M.: Some Computer Science Issues in Ubiquitous Computing. In: Communications of the ACM, 36/7, July 1993

Wellner, P.: Interacting with Paper on the DigitalDesk. In: Communications of the ACM, 36/7, July 1993

Acknowledgement

I would like to thank my colleagues contributing to this concept in theory and practice: Herman Gathmann, Hauke Ernst, Jürgen Huyer, Kai Schmudlach, Rainer Pundt. Our research is being supported by the Deutsche Forschungsgemeinschaft DFG (G-Nr. Br 1556/2-3, G-Nr. Br1556/3-3) and the EU (MM1002 and IST2031).

Further related publications

- Bruns, F. W. (2001): Learning in mixed Realities. Proceedings of i3 Spring Conference: (inter)facing tomorrow. Workshop on Moving between the physical and digital: exploring and developing new forms of mixed-reality user experience, 23.-25. 4. 2001, Porto
- Bruns, F. W. (2001): Web-based cooperative Teaching and Learning of Mechatronics in vocational Education – New Forms of mixed Realities. Proceedings of i3 Spring Conference: (inter)facing tomorrow. Workshop on Web Based Platforms for Cooperative Learning, 23.-25. 4. 2001, Porto
- Hornecker, E. / Robben, B. / Bruns, F.W. (2001): Technische Spielräume: Gegenständliche Computerschnittstellen als Werkzeug für erfahrungsorientiertes, kooperatives Modellieren. In: Ingo Matuschek/ Annette Henninger/ Frank Kleemann (Hrsg.) (2001): Neue Medien im Arbeitsalltag. Empirische Befunde, Gestaltungskonzepte, Theoretische Perspektiven. Opladen, Westdeutscher Verlag (im Erscheinen)
- Schäfer, K., Bruns, F. W. (2001): PLC-Programming by Demonstration with graspable Models. Proceedings of 6th IFAC Symposium on Cost Oriented Automation. Berlin, 8.-9. 10. 2001, in print
- Bruns, F. W. (2000): Complex Objects and anthropocentric Systems Design. In: L.M. Camarinha-Matos, H. Afsarmanesh, H.-H. Erbe (Ed.), Advances in networked Enterprises: Virtual Organizations, Balanced Automation and Systems Integration, Kluwer Academic Publishers, S. 249-258
- Hornecker, E. / Bittner, P. (2000): Kritisch studieren ... und dann? Editorial der FIF-Kommunikation 1/2000. (S. 3, S.8)
- Hornecker, E. / Bittner, P. (2000): Vom kritischen Verhältnis zur Berufspraxis in der Informatik - Ergebnisse einer Befragung. FIF-Kommunikation 1/2000, (S. 33-39)
- Hornecker, E. / Robben, B. / Bruns, F.W. (2000): Technische Spielräume: Gegenständliche Computer-Schnittstellen als Werkzeug für erfahrungsorientiertes, kooperatives Modellieren. In: Neue Medien Im Arbeitsalltag -- Empirische Analysen, Gestalterische Impulse, Theoretische Befunde. Interdisziplinäre Tagung der DFG-Forschergruppe "Neue Medien im Alltag" in Chemnitz, 10. und 11. November 2000. Workshopreader
- Müller, D. (2000): Hypermediagestützte Simulationssysteme - Neue Software-Werkzeuge in der beruflichen Bildung. In: Arbeitsgemeinschaft Berufliche Bildung (Hrsg.): Hochschultage Berufliche Bildung 1998. Neusäß. S. 197-208
- Müller, D./Ernst, H. (2000): Eine Konzeptstudie zur Realisierung des Autorensystems MentorAuthor. Forschungsbericht, Universität Bremen. 2000
- Müller, D./Bruns, F.W. (2000): Software zur Förderung von Arbeitsprozesswissen. In: Fischer, M./Rauner, F. (Hrsg.): Lernfeld: Arbeitsprozess. Baden-Baden (im Druck)
- Seehusen, S. / Hornecker, E. (2000): Programmierkurs Java – Konzepte und Erfahrungen. Erscheint in :Veronika Oechtering, Karin Vosseberg (Hrsg.) Informatica Feminale. Leske+Budrich
- Schmudlach, K. / Hornecker, E. / Ernst, H. / Bruns, F.W. (2000): Bridging Reality and Virtuality in Vocational Training. In: CHI 2000 Extended Abstracts (Interactive Poster). (S. 137-138). ACM 2000

- Bruns, F. W. (1999): Complex Construction Kits for Engineering Workspaces, in: Streit, N. A., Siegel, J., Hartkopf, V., Konomi, S. (Hrsg.): Cooperative Buildings – Integrating Information, Organizations and Architecture. Second Int. Workshop, CoBuild'99. Carnegie Mellon. Lecture Notes of Computer Science 1670, Heidelberg: Springer, S. 55-68
- Bruns, F. W. (1999): Auto-erecting Agents for Collaborative Learning Environments, in: Proceedings of The Eighth IEEE Intern. Workshop on Enabling Technologies: Infrastructure for Collaborative Enterprises (WET-ICE '99), Stanford, USA: IEEE Computer Society Press, S. 287-288
- Bruns, F. W. (1999): Qualifizierung zwischen Wirklichkeit und Virtualität, in: Rauner, F.; Stuber, F. (Hrsg.): Berufsbildung für die Facharbeit in der Elektro- und Informationstechnik, Bremen: Donat Verlag, S. 25-39
- Ernst, H.; Schäfer, K.; Bruns, W. (1999): Creating Virtual Worlds with a Graspable User Interface. Interactions in Virtual Worlds. Proceeding of the Twente Workshop on Language Technology, TWLT 15, Enschede: Universiteit Twente, S. 45-57
- Hornecker, E. / Robben, B. (1999): Vocational Training with combined real/virtual environments. In: H.-J. Bullinger & J. Ziegler (Eds.): Proceedings of the 8th International Conference on Human-Computer Interaction, HCI '99, München.. Mahwah: Lawrence Erlbaum, Vol. 2, (S. 730 - 734)
- Hornecker, E. / Schäfer, K. (1999): Gegenständliche Modellierung virtueller Informationswelten. Software Ergonomie'99 – Design von Informationswelten (SE'99). GI-Fachtagung '99, Walldorf, Baden. Teubner 1999 (S. 149–159) (auch erschienen als artec paper 65, November 1999)
- Müller, D. (1999): Probleme bei der Nutzung des World Wide Web als Lehr- und Lernmedium. In: Der Senator für Bildung und Wissenschaft (Hrsg.) (1999): Modellversuch "Berufliche Bildung und internationale Datennetze (BeNet)". Abschlussbericht. Bremen. S. 81-101
- Müller, D. (1999): Die Nutzung des Internet als Informationsquelle im Unterricht. In: Der Senator für Bildung und Wissenschaft (Hrsg.) (1999): Modellversuch "Berufliche Bildung und internationale Datennetze (BeNet)". Abschlussbericht. Bremen. S. 103 - 115
- Bruns, F. W. (1998): Integrated Real and Virtual Prototyping, in: Proceedings of "The 24th Annual Conference of the IEEE Industrial Electronics Society", Session: "Virtual Prototyping", S. 2137-42
- Bruns, F. W. (1998): Arbeiten und begreifen, in: Rügge, I.; Robben, B.; Hornecker, E.; Bruns, F. W. (Hrsg.): Arbeiten und begreifen: Neue Mensch-Maschine-Schnittstellen, Münster, Hamburg: LIT Verlag, S. 9-16
- Hornecker, E. (1998): Coupling Physical Artifacts and Abstract Representations. ED-Media 98, Freiburg. AACE 1998 (S. 1749-1750) CD-ROM-Proceedings
- Hornecker, E. / Robben, B. (1998): Lernen und Begreifen – Pneumatikunterricht in einer Real Reality-Umgebung. Artec paper Nr. 62 September 1998
- Hornecker, E. (1998): Wo "tangible" und "virtual" sich berühren –Augmented Reality, Labilbaukästen und Real Reality. In: Rügge et al (Hrsg). (S. 173-186)
- Hornecker, E. (1998): Programmieren als Handwerkszeug im ersten Semester. In: Volker Claus (Hrsg). Informatik und Ausbildung, GI-Fachtagung '98, 30.3. - 1.4.1998, Stuttgart. Springer, Informatik Aktuell 1998 (S. 43-51)

- Müller, D. (1998): Hypermediagestützte Simulationssysteme. In: berufsbildung. Zeitschrift für Praxis und Theorie in Betrieb und Schule. Juni 1998. 52. Jahrgang. S. 8-10
- Müller, D. (1998): Simulation und Erfahrung - Ein Beitrag zur Konzeption und Gestaltung rechnergestützter Simulatoren für die technische Bildung. Dissertation Universität Bremen
- Robben, B. / Hornecker, E. (1998): Gegenständliche Modelle mit dem Datenhandschuh begreifen – Eine Lernumgebung für den Technikunterricht. In: Volker Claus (Hrsg). Informatik und Ausbildung, GI-Fachtagung '98, 30.3. - 1.4.1998, Stuttgart. Springer, Informatik Aktuell 1998 (S. 123-132)
- Robben, B. / Hornecker, E. (1998): Erfahrung orientiert Lernen – Pneumatik unterrichten mit "Real Reality". Poster auf dem 44. Arbeitswissenschaftlichen Kongreß "KOMMUNIKATION UND KOOPERATION", Jahrestagung der Gesellschaft für Arbeitswissenschaften, 18. bis 20. März 1998, Bremen
- Rügge, I.; Robben, B.; Hornecker, E.; Bruns, F. W. (Hrsg.) (1998): Arbeiten und begreifen: Neue Mensch-Maschine-Schnittstelle, Münster: LIT-Verlag, S. 9-16 (=Band 9 der Reihe Arbeitsgestaltung - Technikbewertung - Zukunft, hrsg. von Müller, W. und Senghaas-Knobloch, E.)
- Brauer, V. / Bruns, F.W. / Hornecker, E. / Robben, B. / Rosch, H. / Rügge, I. / Schäfer, K. (1997): Vom Bildschirm zum Handrad -- Computer(be)nutzung nach der Desktop-Metapher - artec-paper 54. Universität Bremen. Oktober 1997 (Materialien zum Workshop, 6.-7. Oktober 1997) (S. 19)
- Bruns, F. W. (1997): Übergänge zwischen realen und virtuellen Lernumgebungen zur Instandhaltungsausbildung. In J. P. Pahl (Hrsg.), Lern- und Arbeitsumgebungen zur Instandhaltungsausbildung. Kallmeyer'sche Verlagsbuchhandlung, Seelze-Velber
- Bruns, F. W. (1997): Sinnlichkeit in der Technikgestaltung und Technikhandhabung - Ein konstruktiver Ansatz. In Schachtner (Hrsg.), Technik und Subjektivität. Suhrkamp Verlag, Frankfurt
- Bruns, W., Schäfer, K. & Brauer, V. (1997): A new Approach to Human-Computer Interaction – Synchronous Modelling in Real and Virtual Spaces. Proceedings of Designing Interactive Systems (DIS '97), Amsterdam
- Bruns, W./Müller, D. (1997): Modellversuch: Hypermediagestützte Simulationssysteme für berufliche Schulen (HYSIM). Abschlußbericht. Bremen, Senator für Bildung, Wissenschaft, Kunst und Sport
- Hornecker, E. (1997): Real-Reality – ein Konzept für kooperative Lern- und Arbeitsumgebungen. In:
- Hornecker, E. (1997): Die Wiederentdeckung des Subjekts in der Arbeit – Gestaltung von Arbeit für Subjekte. In: FIFF--Kommunikation 4/97 (S. 28 –30)
- Müller, D. (1997): Lernen mit Simulatoren. In: Der Senator für Bildung, Wissenschaft, Kunst und Sport Bremen (Hrsg.) (1997): Modellversuch "Hypermediagestützte Simulationssysteme für berufliche Schulen (HYSIM)". Abschlußbericht. Bremen. S. 23-54
- Müller, D. (1997): Möglichkeiten hypermediagestützter Simulation. In: Der Senator für Bildung, Wissenschaft, Kunst und Sport Bremen (Hrsg.) (1997): Modellversuch "Hypermediagestützte Simulationssysteme für berufliche Schulen (HYSIM)". Abschlußbericht. Bremen. S. 81-96
- Müller, D. (1997): Studien zur Implementierung von Simulationen mit Hilfe von Hypermedia-Entwicklungssystemen. In: Der Senator für Bildung, Wissenschaft,

- Kunst und Sport Bremen (Hrsg.) (1997): Modellversuch "Hypermediagestützte Simulationssysteme für berufliche Schulen (HYSIM)". Abschlußbericht. Bremen. S. 129-136
- Müller, D. (1997): Vom Bildschirm zum Handrad - eine Anmerkung aus technikdidaktischer Sicht. In: Bruns, F. W. u.a.: Vom Bildschirm zum Handrad. Computer(be)nutzung nach Desktop-Metapher, Workshop, 6.-7. Oktober 1997. artec - paper Nr. 54. Bremen
- Müller, D. (1997): Zusammenfassung der Ergebnisse. Modellversuch "Hypermediagestützte Simulationssysteme für berufliche Schulen (HYSIM)". In: Der Senator für Bildung, Wissenschaft, Kunst und Sport Bremen (Hrsg.) (1997): Modellversuch "Hypermediagestützte Simulationssysteme für berufliche Schulen (HYSIM)". Abschlußbericht. Bremen. S. 247-263
- Robben, B. (1997): Computerbenutzung nach der Desktop-Metapher. In: Brauer et al (Hrsg.)
- Bruns, F. W. (1996): Sinnlichkeit in der Technikgestaltung und -handhabung - Ein konstruktiver Ansatz. In C. Schachtner (Hrsg): Technik und Subjektivität. Suhrkamp
- Bruns, F. W., Brauer, V. (1996): Greifendes und begreifendes Modellieren im Realen und Virtuellen. 7. GI-Workshop „Hypermedia und KI“. Hannover, Nov. 95
- Bruns, W., Brauer, V. (1996): Bridging the Gap between Real and Virtual Modeling - A New Approach to Human-Computer Interaction -. IFIP5.10-Workshop „Virtual Prototyping“, May 6-8, Arlington, Texas (also as artec Paper Nr. 46, Universität Bremen)
- Bruns, W., Müller, D. (1996): Lernförderliche Übergänge zwischen gegenständlichen und abstrakten Modellen. artec Paper Nr. 43, Universität Bremen
- Bruns, W. (1996): Grasping, Communicating, Understanding - Connecting Reality and Virtuality -. AI & Society, Vol 10, Nr 1, 1996, pp 6-14, auch als artec Paper Nr. 44)
- Müller, D./Herzog, H./Tussinger, P. (1996): Hypermediagestützte Simulationssysteme für berufliche Schulen – Bericht aus einem Modellversuch. In: Jenewein, K. (Hrsg.) (1996): Fachtagung Elektrotechnik und Metalltechnik. Bildung und Beruf – Wege zur Entwicklung von Handlungskompetenz in der dualen Berufsausbildung. Neusäß. S. 105-113